

# STRATOS XP

## *PIZZA*

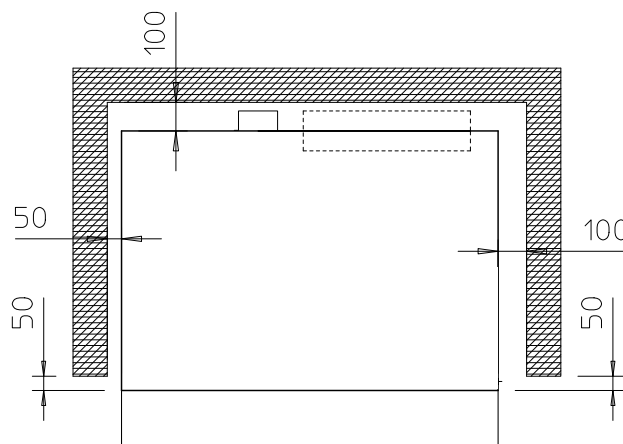

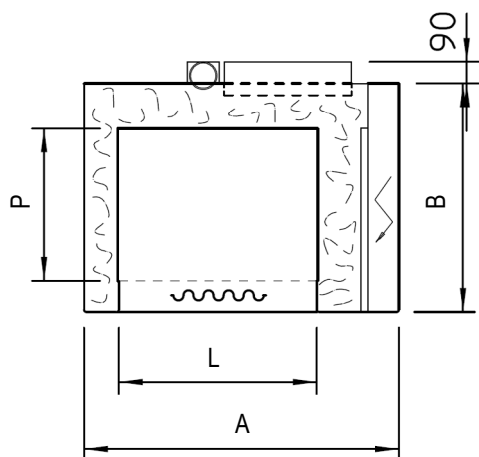
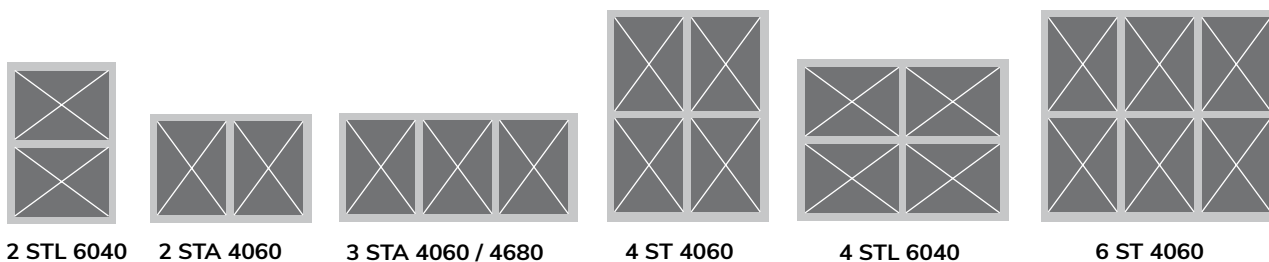

#### CAMERA / DECK

Modello Model	Capacità teglie Tray capacity	Capacità pizze Pizza capacity	A mm	B mm	L mm	P mm	Peso Weight kg	kW standard	kW Super Power	Vaporiera Steamer kW
2STL 6040	N°2 40X60	n°5 pizze Ø30	980	1110	620	810	120	4,5	7	1,0
2STA 4060	N°2 40X60	n°5 pizze Ø30	1220	910	830	610	130	4,8	6,8	
3STA 4060	N°3 40X60	n°8 pizze Ø30	1630	910	1240	610	160	7	10	
3STA 4680	N°3 46X80	n°10 pizze Ø30	1810	1110	1420	810	180	9,9	15,4	
4STL 6040	N°4 40X60	n°11 pizze Ø30	1630	1110	1240	810	180	9	14	
4ST 4060	N°4 40X60	n°11 pizze Ø30	1220	1510	830	1210	180	8,2	13,6	
6ST 4060	N°6 40X60	n°16 pizze Ø30	1630	1510	1240	1210	230	9,5	15,8	

#### CELLA / PROOFER

Modello / Model	Numero Padelle / Trays number	Peso / Weight kg	kW
2STL 6040 H93/73	N° 16/10 40x60	90/80	1,0
2STA 4060 H93/73	N° 24/15 40x60	90/80	
3STA 4060 H93/73	N° 32/20 40x60	100/90	
3STA 4680 H93/73	N° 16/10 46x80	110/100	
4STL 6040 H93/73	N° 32/20 40x60	100/90	
4ST 4060 H93/73	N° 24/15 40x60	100/90	
6ST 4060 H93/73	N° 32/20 40x60	110/100	

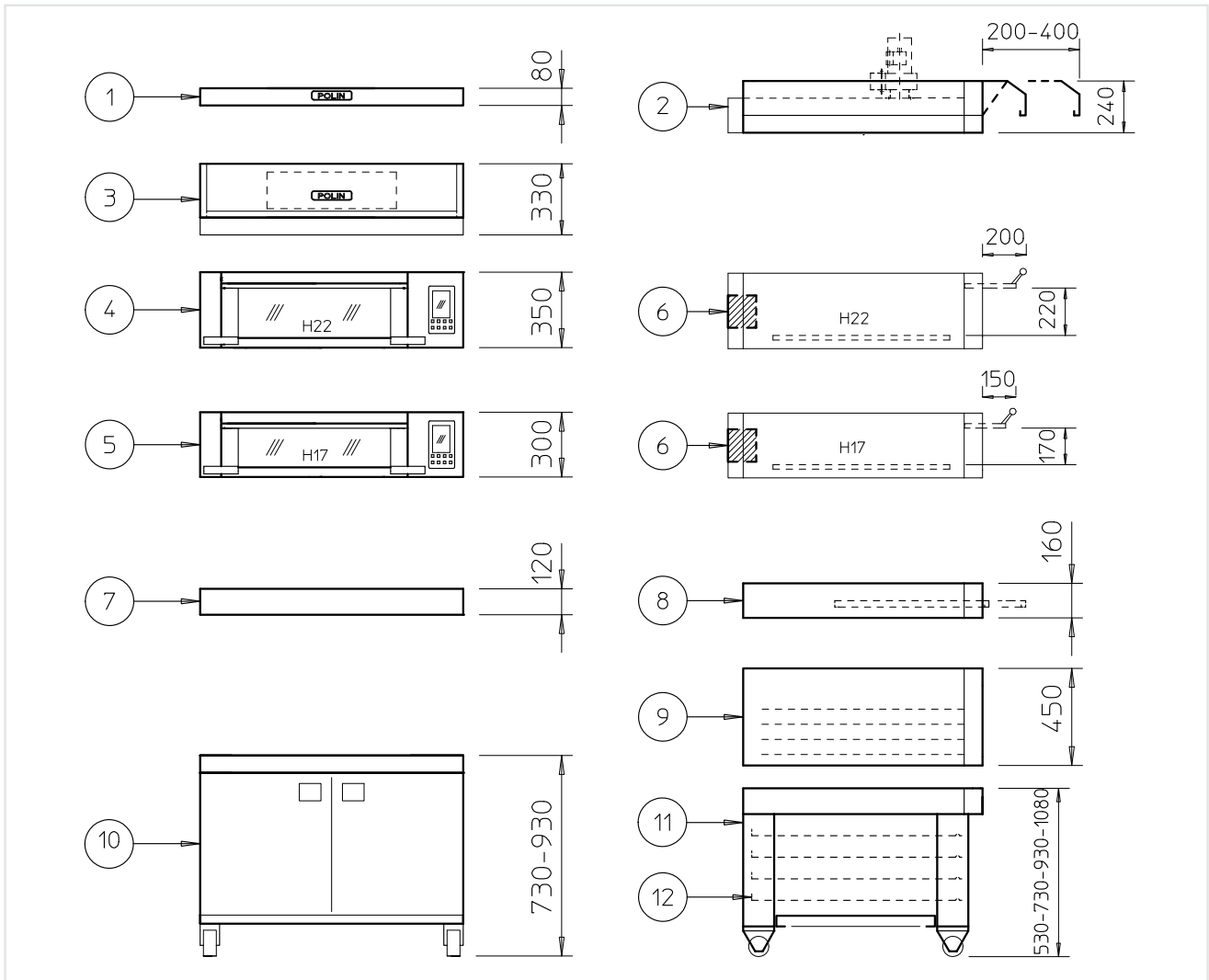

1	Elemento superiore	Upper section
2	Cappa con/senza aspiratore <sup>(1)</sup>	Hood with/without fan <sup>(1)</sup>
3	Cappa con condensatore ad aria <sup>(1)</sup>	Hood with air steam condensing unit <sup>(1)</sup>
4	Camera h 22	Deck h 22
5	Camera h 17	Deck h 17
6	Vaporiera	Steam generator
7	Elemento inferiore	Lower section
8	Elemento inferiore con piano estraibile	Lower section with sliding tray support
9	Box intermedio porta padelle altezza	Intermediate box with trays holder
10	Cella di lievitazione e basamento carenato su ruote <sup>(2)</sup>	Proof-box/ base with side panels on wheels <sup>(2)</sup>
11	Sostegno in lamiera inox con pavimento e ruote <sup>(2)</sup>	Stainless steel support with floor and wheels <sup>(2)</sup>
12	Rastrelliera porta padelle per sostegno in lamiera inox	Tray holders for stainless steel support

<sup>(1)</sup> COMPRENDE ELEMENTO SUPERIORE / INCLUDES UPPER ELEMENT

<sup>(2)</sup> COMPRENDE ELEMENTO INFERIORE / INCLUDES LOWER ELEMENT

## CARATTERISTICHE DI SERIE

### **OGNI CAMERA É DOTATA DI:**

- Temperatura massima 300 °C con portina in cristallo
- Temperatura massima 450 °C con portina coibentata
- Facciata e rivestimento laterale inox
- Resistenze corazzate in acciaio inox imbrunite
- Agganci in bocca per telaino di informamento
- Computer Hybrid Control 5" 100 programmi di cottura con funzioni speciali di controllo e risparmio energetico
- Funzioni avanzate esclusive e brevettate:
  - > parzializzatore dinamico di energia (PRD)
  - > QR code dinamico di diagnosi anomalia
- Valvola scarico vapori automatica
- Accensione e spegnimento automatico
- Sistema di controllo dinamico a 3 zone (TZS) bocca, centro e fondo
- Controllo e regolazione temperatura platea e cielo
- Controllo e regolazione temperatura bocca
- Termostato di sicurezza
- Tecnologia Plug-in per assemblaggio veloce
- Alimentazione standard singole camere 380-400-415/50/3N

### **LA CELLA DI LIEVITAZIONE É COSTRUITA IN ACCIAIO INOX ED É DOTATA DI:**

- Regolazione e controllo riscaldamento
- Regolazione e controllo umidità con sonda
- Ventilazione interna per miglior distribuzione dell'umidità
- Comando cella da Touch screen camera cottura
- Elettrovalvola antiallagamento
- Ruote
- Alimentazione standard 220-230-240/50-60/1N

### **IL SUPPORTO IN LAMIERA INOX É DOTATO DI:**

- Elemento isolante inferiore
- Gambe in lamiera inox (varie altezze)
- Pavimento inox rinforzato
- Ruote

### **LA CAPPA IN ACCIAIO INOX É DOTATA DI:**

- Frontale inox, allungabile da 200 a 400mm con altezza minima sotto cappa 2100mm
- Condotto di collegamento camere-cappa per unica uscita vapore (anche per versione senza aspiratore)
- Regolazione aspirazione camere tramite serranda
- Aspiratore vapori maggiorato di serie su modello 6ST 4060

## STANDARD FEATURES

### **EACH DECK IS EQUIPPED WITH:**

- *Maximum temperature: 300 °C with GLASS door*
- *Maximum temperature: 450 °C with INSULATED door*
- *Stainless steel front and sides*
- *Darkened stainless steel armoured heating elements*
- *Hooks in the mouth for manual loader*
- *Hybrid Control 5" Computer, 100 baking programs. with special control and energy-saving functions*
- *Exclusive and patented advanced functions:*
  - > *Dynamic Energy Partializer (PRD)*
  - > *Dynamic QR code for fault diagnosis*
- *Automatic steam discharge valve*
- *Start and automatic stop*
- *3-zone dynamic control system (TZS) mouth, center and rear*
- *Control and regulation of top and bottom temperature*
- *Mouth temperature control and regulation*
- *Safety thermostat*
- *Plug-in technology for fast assembly*
- *Standard power supply single chamber 380-400-415/50/3N*

### **THE PROOF-BOX IS BUILT IN STAINLESS STEEL AND IS EQUIPPED WITH:**

- *Heating control and regulation*
- *Humidity control and regulation with probe*
- *Internal ventilation for better moisture distribution*
- *Proof-box is controlled by oven's Touch Screen*
- *Anti-flooding solenoid valve*
- *Wheel*
- *Standard power supply 220-230-240/50-60/1N*

### **THE STAINLESS-STEEL SUPPORT IS EQUIPPED WITH:**

- *Lower insulating element*
- *Legs in stainless steel sheet (various heights)*
- *Reinforced stainless-steel floor*
- *Wheels*
- *Tray holder rack (optional)*

### **THE STAINLESS-STEEL HOOD IS EQUIPPED WITH:**

- *Stainless-steel front, extendable from 200 to 400 mm with minimum height under hood of 2100 mm*
- *Chamber-hood connection duct for single steam outlet (also for version without the aspirator)*
- *Chamber suction regulation through damper*
- *Reinforced aspirator steam standard on 6ST 4060 model*

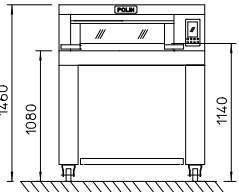
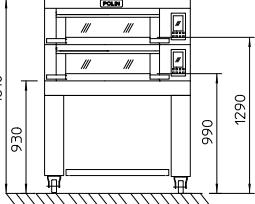
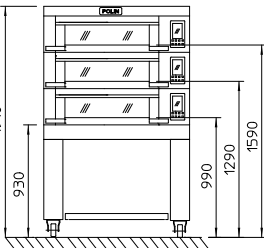
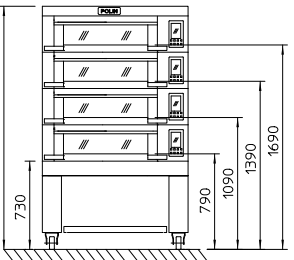
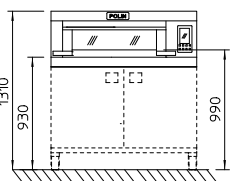
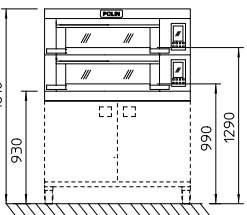
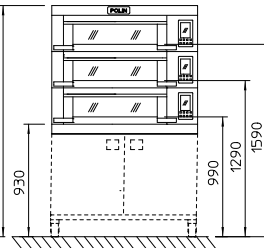
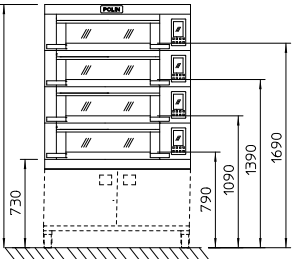
Forni Ovens	1 CAMERA / DECK H17	2 CAMERA / DECKS H17	3 CAMERA / DECKS H17	4 CAMERA / DECKS H17
Sostegno inox su ruote Aluminum stand on wheels				
Cella / basamento carenato su ruote Proof box / base with side panel + wheels				
<p><b>NB: Per ogni camera H22 aggiungere 50 mm in altezza / NOTE: For each deck H22 add 50 mm in height</b></p>				